

CLEMSA

EXTERIOR RECEIVER

12V - 230V

MUTAN-II



RN 42 / RN 44

TECHNICAL
MANUAL

LOCATION OF MAIN COMPONENTS

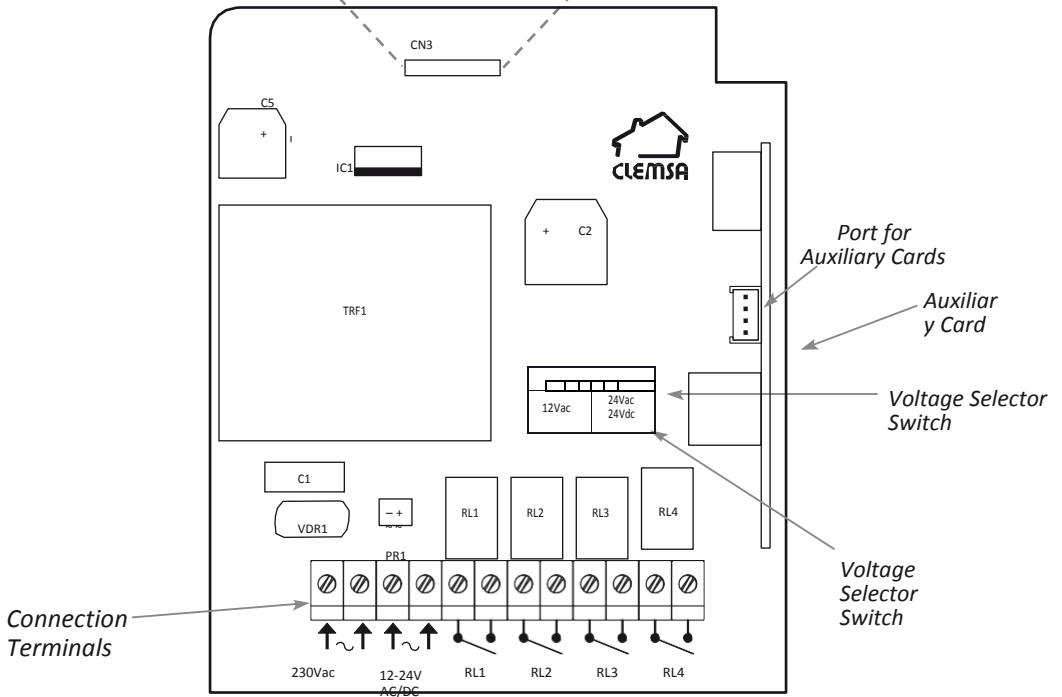
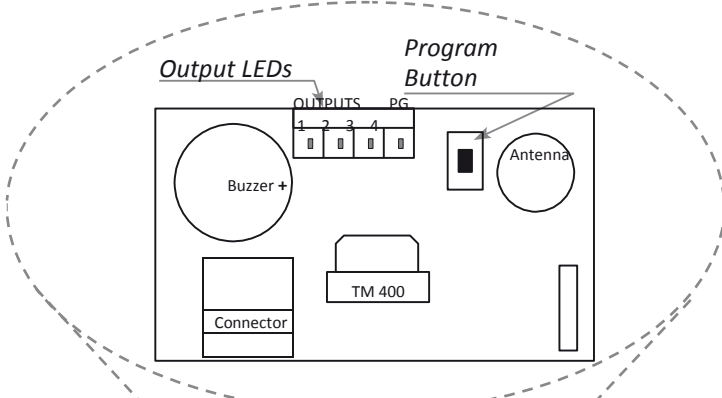

INDEX

	<u>Page</u>
1. DESCRIPTION	4
2. INSTALLATION	4
3. CONNECTION	5
4. PROGRAMMING	5
5. USE	7
5.1. Transmitter replacement	7
5.2. Receiver output configuration	7
5.3. Enable Radio-Supervised Authorization	8
5.4. Deleting Transmitters	9
5.5. Antispoofing System	9
6. OPTIONAL ACCESSORIES	9
7. TECHNICAL CHARACTERISTICS	9
8. PROGRAMMING QUICK GUIDE	10
9. DECLARATION OF CONFORMITY	11



1. DESCRIPTION

Thank you for trusting CLEMSA for your home automation remote control system needs. Exterior Receivers Rn 42 and RN 44 are versatile receivers in the MUTAN II family with relay **MUTAN-II** outputs, with power source options for 230Vac or 12V to 24V. ac/dc.

The **MUTAN-II** family is an evolution of the successful **MUTANcode** family, with new features added to increase its security.

These features include:

- A unique key for each system.
- Direct, Supervised, or button authorization.
- Antispoofing system.
- Multi-frequency or selectable frequency.

These new **MUTAN-II** Receivers represent a technological milestone by combining 433MHz and 868 MHz frequencies in the same receiver, working simultaneously.

The RN 42/44 Receiver ships standard with the **MUTANcode** system, which is compatible with current Programmers. If you wish to operate it with the additional adventures **MUTAN-II** provides, introduce an installation key using one of the programmers available for the MUTAN II family.

2. INSTALLATION

Avoid installing the Receiver near metallic tubes and cables to prevent electromagnetic interference.

Do not install the Receiver less than 10 meters from unapproved regenerative receivers; these receivers generate interference that may affect the proper function of the system.

Install the receiver in an elevated area, avoiding metallic surfaces between the transmitter and receiver where possible. Connect the cables according to the connections diagram so they are extending from the bottom part of the box, making as small a hole as possible in the wire pass-through, to preserve water resistance.

Make the connections with the control panel unpowered. You can power the system at 230Vac or 12-24Vac/dc; if you choose to power it at 12V or 24V, configure the voltage selection switch before making the connection.

Warning: *If you are connecting a TD420 decryption card to the auxiliary port, along with two CK40/42 RFID locks, it is recommended the system be powered at 230Vac, 12Vac or 24Vdc.*

If powered at 24Vac, some components may reach high temperatures, and touching them represents a burn risk.



3. CONNECTION

RN 42

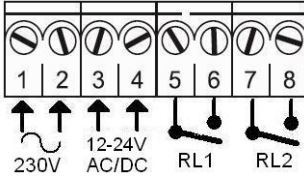

- 1-2: 230Vac Power
- 3-4: 12 to 24V ac/dc power according to switch setting.
- 5-6: NO Contact, receiver port 1
- 7-8: NO Contact, receiver port 1
- 9-10: NO Contact, receiver port 1
- 11-12: NO Contact, receiver port 1

RN 44

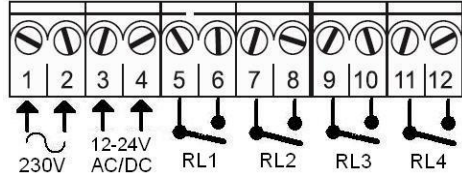

4. PROGRAMMING

The Receiver features 3 transmitter programming modes.

- a) By the program key.
- b) Radio supervised authorization (if enabled).
- c) Direct Authorization (if available. Only **MUTAN-II** applies to MUTAN II).

Modes a and b:

1. **Mode a.** Press the program button. You will hear 2 short beeps. It is now in programming or learning mode. (Fig. 1).

Mode b. If radio programming is enabled (see section 5.3), you can access programming mode in the Receiver with a “working” transmitter.

Press the button hidden under the battery cover of a working transmitter, and the Receiver will enter programming or learning mode, as indicated by 2 short beeps. (Fig. 2).

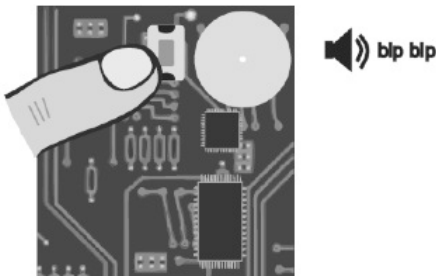

Fig. 1



Fig. 2



2.- Once in programming mode you can authorize the desired transmitters by pressing any button on each transmitter; for each transmitter programmed a short beep will sound. (Fig. 3)

3.- To exit programming mode you may do the following: (Fig. 4)

- Wait 30 seconds for the Receiver to leave programming mode on its own.
- Press the program button on the Receiver.
- Press a channel on any of the transmitters that has been authorized other than the last one programmed.

The Receiver indicates that it has left programming mode with 3 short beeps.



Fig. 3

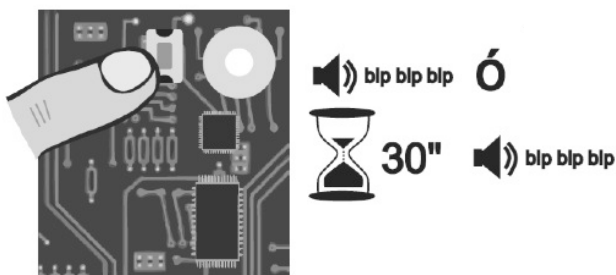

Fig. 4

Mode c:

If Direct Authorization programming mode is enabled, pressing any button on a transmitter near the Receiver will automatically authorize it as long as the Personalization and Installation Key match. For each transmitter programmed a short beep will sound.

Possible programming issues

If you hear 3 short beeps when trying to program a transmitter, this means the Receiver has left Programming mode, as the transmitter had already been programmed previously.

If no beeps sound when trying to program a transmitter, the transmitter's personalization or installation key does not match those of the Receiver.

If when trying to program a transmitter 3 double beeps sound, this means the Receiver's memory is full and that transmitter has not been programmed.

5. USE

Once the transmitters are programmed in the Receiver, pressing a channel will activate the corresponding Receiver outputs.

WARNING, once working, with the Installation Key, the Memory Card will be linked to the receiver and can only be reused in a new Receiver through the use of the programmer. See its instructions.

5.1. TRANSMITTER REPLACEMENT

With a replacement transmitter previously recorded with a programmer, the user can automatically authorize the new transmitter by pressing it a couple of times in the vicinity of the receiver, the old transmitter becoming deauthorized.

5.2. RECEIVER OUTPUT CONFIGURATION

By default, the Receivers come configured such that output 1 is activated when it receives channel 1, and output 2 when it receives channel 2, but there are certain circumstances in which it is necessary to change this configuration.

We can change the configuration using a compatible Programmer or manually, so let's proceed to the next form:

With the receiver connected and working, extract the TM 400 memory card (Fig. 5) and press the receiver program button (Fig. 6). 3 beeps will sound and the LED corresponding to output 1 will light up. If you wish to change the channel associated to this output, press the desired channel on a transmitter in the system (Fig. 7) (the receiver will emit a beep upon accepting the new channel), if you do not wish to change the output simply press the receiver program button and go on to output 2 of the receiver, and so on. After configuring output 4 and pressing the receiver program button (Fig. 8), it will leave channel programming mode, three long beeps will sound and it will continue beeping until the TM 400 card is inserted again (Fig. 9). The outputs are now configured, you can change this configuration at any time.



Fig. 5

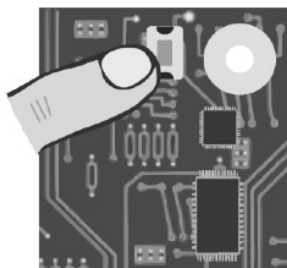

Fig. 6



Fig. 7

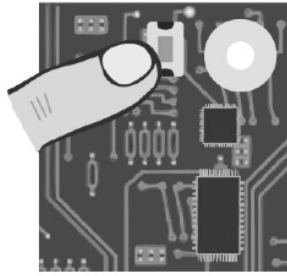

Fig. 8

Fig. 9



Fig. 10

5.3. ENABLE RADIO-SUPERVISED AUTHORIZATION

Standard the receivers only have the button authorization option; if you want to change the type of authorization to Supervised or Direct, you can use the Programmer or manually enable the Supervised Authorization mode in the following manner:

With the receiver connected and working, extract the TM 400 memory card (Fig. 5) and press the receiver program button (Fig. 6). 3 beeps will sound and the LED corresponding to output 1 will light up (Fig. 6). Now press the program button on a transmitter already authorized by the receiver; one short beep and one long one will sound (Fig. 10), indicating that Supervised Authorization mode has been activated. Press the receiver program button repeatedly until it leaves this mode (Fig. 8) and insert the TM 400 card again (Fig. 9).

To disable Supervised Authorization mode, proceed in the same manner, in this case two short and one long beep will sound.



5.4. DELETING TRANSMITTERS

To delete all users from your Receiver, press its program button and hold it down for 10 seconds; you will hear 6 double beeps indicating the memory has been erased.



If you only wish to erase one particular user, you must use a compatible programmer.

5.5. ANTISPOOFING SYSTEM

When the receiver detects that there are 2 transmitters with the same code functioning in the system, it puts them on "Reserve" in the memory card and they stop working. For this transmitter to work again it must be set to "Active", editing the TM400 card with a compatible programmer.

To avoid issues, it is recommended this code be left on "Reserve" and the original transmitter code changed for a new one authorizing it with the receiver.

6. OPTIONAL ACCESSORIES

- PT Programmers

7. TECHNICAL CHARACTERISTICS

	RECEIVER RN 42	RECEIVER RN 44
POWER SOURCE	230Vac or 12-24V ac/dc	230Vac or 12-24V ac/dc
CONSUMPTION	60mA	60mA
FREQUENCY	433.92Mhz / 868.35Mhz.	433.92Mhz / 868.35Mhz.
No. USERS	400	400
No. OUTPUTS (RELAYS)	2	4
RELAY CONTACTS	1A.	1A.
FUNCTIONAL	-20 to +70°C	-20 to +70°C
WATER RESISTANCE	IP 54	IP 54
DIMENSIONS	150x100x60mm.	150x100x60mm.
WEIGHT	454 g	470 g



8. PROGRAMMING QUICK GUIDE

PROGRAMMING SEQUENCE

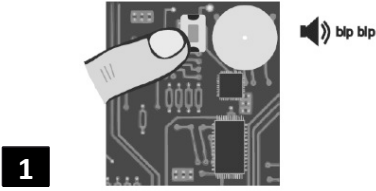

OR

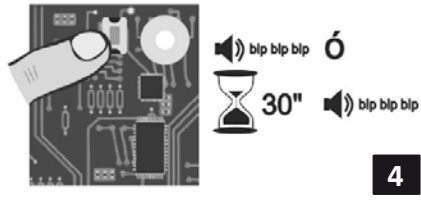

OUTPUT CONFIGURATION OR ENABLING SUPERVISED AUTHORIZATION

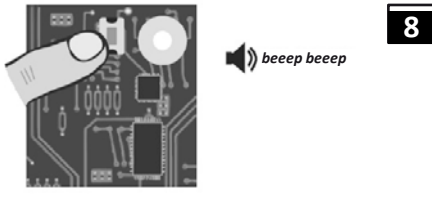
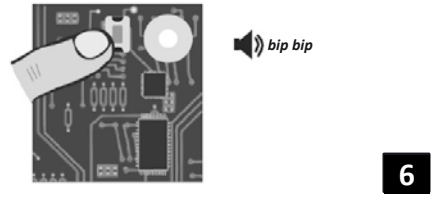
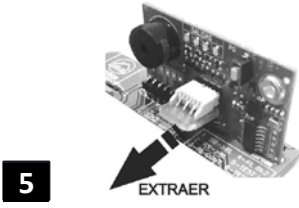

OR

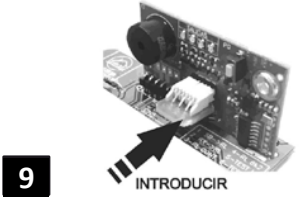

9.DECLARATION OF CONFORMITY

DECLARATION OF CONFORMITY

We, CLEM, S.A.U.
Nosotros, Avda. de la Fuente Nueva, 12. Nave 8.
28703 San Sebastián de los Reyes – Madrid (ESPAÑA), CIF: A-28499481

Declare under our sole responsibility that the product:

Declaramos bajo nuestra exclusiva responsabilidad la conformidad del producto:

Product: RECEIVER FOR REMOTE CONTROL/RECEPTOR PARA TELEMANDO
Denominación
Brand name: MUTAN II
Marca
Model: RNE 4248
Modelo
Commercial variants: RNE 248, RNE 248U, RN 42 y RN 44.
Variantes comerciales

To which this declaration relates is in conformity with the requirements of the following directives:
Al que se refiere esta declaración, con las normas u otros documentos normativos:

- ETSI EN 300 220-1 V2.4.1 (2012).
- ETSI EN 300 220-2 V2.4.1 (2012).
- ETSI EN 301 489-1 V1.9.2 (2011).
- ETSI EN 301 489-3 V1.4.1 (2002).
- UNE EN 60215 (1995) + A2 (1995).



the presumption of Conformity with the essential requirements regarding Council Directive 99/05/CE.

de acuerdo con las disposiciones de la Directiva 99/05/CE del Parlamento Europeo y del Consejo de 9 de marzo de 1999, transpuesta a la legislación española mediante el Real Decreto 1890/2000, de 20 de noviembre de 2000.

RoHS Declaration of Conformity *Declaración de conformidad RoHS*

Declare under our sole responsibility that the product:

Declaramos bajo nuestra exclusiva responsabilidad, la conformidad del producto:

Receiver for remote control / Receptor para telemando

Referred to this statement, with the provisions of Directive 2011/65/UE of the European Parliament and the Council of 8th June 2011 on restricting the use of certain hazardous substances in electrical and electronic equipment.

Al que se refiere esta declaración, con las disposiciones de la Directiva 2011/65/UE del Parlamento Europeo y del Consejo de 8 de junio de 2011 sobre restricciones a la utilización de determinadas sustancias peligrosas en aparatos eléctricos y electrónicos.

Lead <0.1% (Plomo <0.1%); Mercury <0.1% (Mercurio <0.1%); Hexavalent chromium <0.1% (Cromo hexavalente <0.1%); PBB <0.1% (Bifenil Polibrominados <0.1%); PBDE <0.1% (Bifenil Eter Polibrominados <0.1%); Cadmium <0.01% (Cadmio <0.01%).

Product complies with RoHS

Producto conforme con la Directiva RoHS



Madrid (Spain), 2013 April 15

Miguel Angel López Albert
CLEM, S.A.U.



FAAC

Simply automatic.

www.clemsa.es

offices

MADRID NORTE Avda. de la Fuente Nueva, nº 12 nave 8 - 28703 S.S. de los Reyes (Madrid) - Tel. **913 581 110** - Fax 917 293 309 - ventas.madrid@clemsa.es

BARCELONA Gorcs Lladó, nº 1-9 naves 6-7 - 08210 Barberá del Vallés (Barcelona) - Tel. **935 880 602** - Fax 935 882 854 - ventas.barcelona@clemsa.es

VALENCIA Sequía Calvera, 5-B (P. I. de Sedaví) - 46910 Sedaví (Valencia) - Tel. **963 186 166** - Fax 963 755 683 - ventas.valencia@clemsa.es
SEVILLA La Red Quince, nº 2 (P. I. La Red Sur) - 41500 Alcalá de Guadaíra (Sevilla) - Tel. **955 631 006** - Fax 955 630 547 - ventas.sevilla@clemsa.es

MADRID SUR Lluvia, nº 14 (P. I. San José de Valderas) - 28918 Leganés (Madrid) - Tel. **916 428 334** - Fax 916 428 335 - ventas.madridsur@clemsa.es

MÁLAGA José Ortega y Gasset, nº 188 nave 3 - (P. I. Alameda) - 29006 (Málaga) - Tel. **952 023 114** - Fax 952 345 064 - ventas.malaga@clemsa.es

GALICIA Avda. Alcalde de Lavadores, nº 115 Bajo - 36214 Vigo (Pontevedra) - Tel. **986 493 120** - Fax 986 484 140 - ventas.galicia@clemsa.es

BILBAO Bastegui, nº 7 (P. I. Artunduaga) - 48970 Basauri (Vizcaya) - Tel. **946 757 092** - Fax 944 264 473 - ventas.bilbao@clemsa.es

MURCIA Avda. Francisco Salcillo, Parc. 22/2 (P. I. Oeste) - 30169 San Ginés (Murcia) - Tel. **968 807 732** - Fax 968 825 753 - ventas.murcia@clemsa.es

CANARIAS Avda. de los Majuelos, nº 42 Edificio Ibis, local 3 - 38107 Santa Cruz de Tenerife - Tel. **922 958 846** - Fax 922 958 731 - ventas.canarias@clemsa.es

DISTRIBUTORS

DISAUT-LEVANTE, S.L. C/ El Salt, 5 - 03550 San Juan de Alicante (Alicante) - Tel. **965 655 332** - Fax 965 655 933 - direccion@disaut.com

DU DETEC, S.L. Echegaray, 37 - 26970 San Pedro de Alcántara (Málaga) - Tel. **952 781 753** - Fax 952 783 786 - carlos@dudetec.com

AUTOMATISMOS ALJARAFE, S.L. Maestra Lucrecia Alfaro, 6 - 41950 Tomares (Sevilla) - Tel. **954 153 944** - Fax 954 154 179 - automatismosaljarafe@yahoo.es

INSTALACIONES ISAMAT, S.L. Avda. Ignacio Wallis, 60 Bj. - 07800 Ibiza (Islas Baleares) - Tel. **971 315 421** - Fax 971 313 862 - correo@isamatibiza.com

ARC SISTEMES ELECTRICS Antonio M^a Alcover, 43 Bj. - 07013 P. de Mallorca (Islas Baleares) - Tel. **971 256 432** - Fax 971 256 181 - gestion@arcsistemas.com

REDES ALTERNATIVAS, S.L. P. I. San Cristóbal, Parcela 15, Nave 2 - 23710 Bailén (Jaén) - Mobile: **620 140 066** - ventas.jaen@clemsafaac.es

PULLDOOR, S.L. Inglaterra, nº 11 - 28400 Collado Villalba (Madrid) - Tel. **918 505 406** - Fax 918 506 173

LUXE PERFIL, S.L. Alhóndiga, 2 (P. I. La Pahlilla) - 46370 Chiva (Valencia) - Tel. **962 521 029** - Fax 962 522 236